

**Nakrętka motylkowa M8**

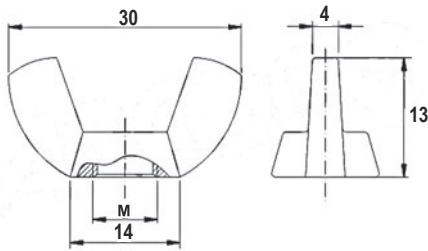

dostępne wersje	INDEX
M8	NMOT
M10	NMOT6

materiał stal  
kolor ocynk biały

**Śruba stołu**

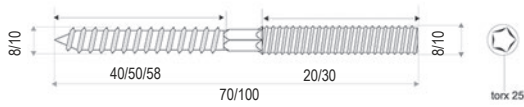

dostępne wersje	INDEX
Ø8/70	SS
Ø10/70	SDM10/10
Ø10/100	SDM10/100

materiał stal  
kolor ocynk biały

**Obejma stołu I**

INDEX: OSR

materiał stal  
kolor ocynk

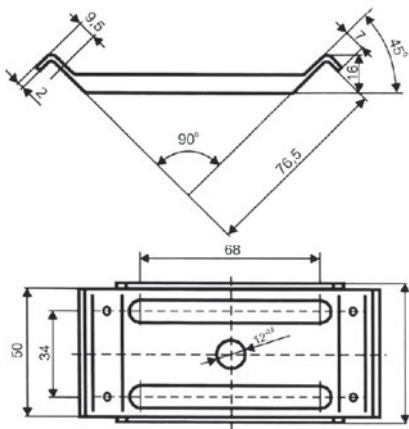

**Obejma stołu II**

INDEX: OS2D

materiał stal  
kolor ocynk

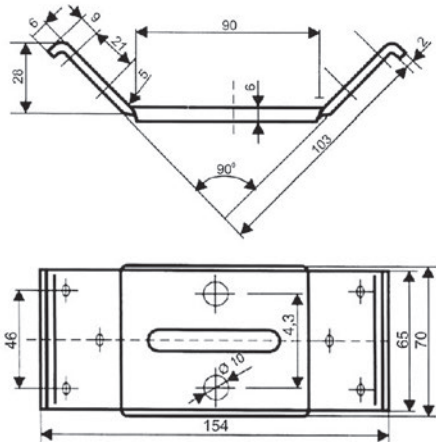

**Kołek ustalający do blatów**

INDEX: ZUS

średnica Ø8  
materiał stal ocynkowana

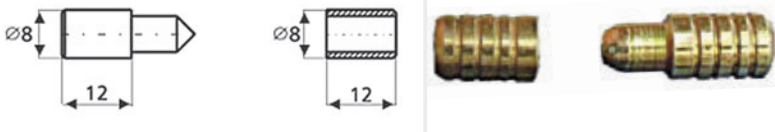

**Zaczep - do stołu mimośrodowy**

INDEX: ZDSMM

średnica Ø8  
materiał stal ocynkowana

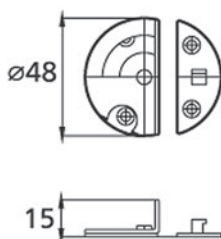

### Zaczepek hakowy do stołów

INDEX: ZHDS

materiał stal ocynkowana

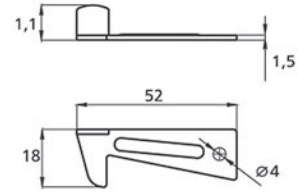

### Zamek do oskrzyń klamrowy

INDEX: ZKL

materiał stal ocynkowana

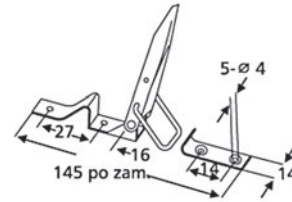

### Prowadnica do stołu

dostępne wersje

INDEX

- L - 60 PDS60
- L - 65 PDS65
- L - 70 PDS70
- L - 75 PDS75
- L - 80 PDS800
- L - 85 PDS85
- L - 90 PS90
- L - 95 PDS95
- L - 100 PDS100
- L - 110 PDS110
- L - 120 PDS120
- L - 130 PDS130
- L - 140 PDS140
- L - 150 PDS150
- L - 160 PDS160

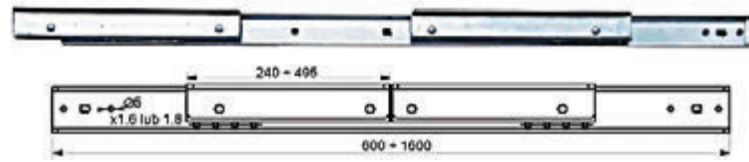

Prowadnica    długość stołu A    wkład B

L-60	90,5	42
L-65	95,5	47
L-70	100,5	52
L-75	105,5	57
L-80	125,5	62
L-85	130,5	67
L-90	135,5	72
L-95	140,5	77
L-100	162	82
L-110	172	92
L-120	182	102
L-130	202,5	104
L-142	206	107
L-150	214	115
L-160	224	122

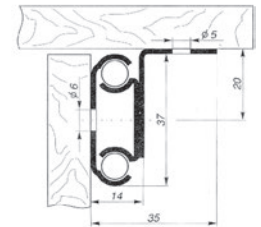
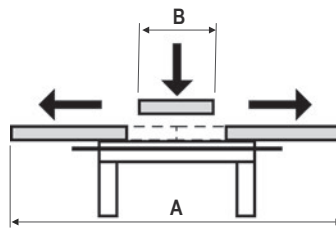

### Prowadnica do stołu SYNCHRO

dostępne wersje

INDEX

- L - 60 PDS60S
- L - 65 PDS65S
- L - 70 PDS70S
- L - 75 PDS75S
- L - 80 PDS80S
- L - 85 PDS85S
- L - 90 PDS90S
- L - 95 PDS95S
- L - 100 PDS100S
- L - 110 PDS110S
- L - 120 PDS120S
- L - 130 PDS130S
- L - 140 PDS140S
- L - 160 PDS160S

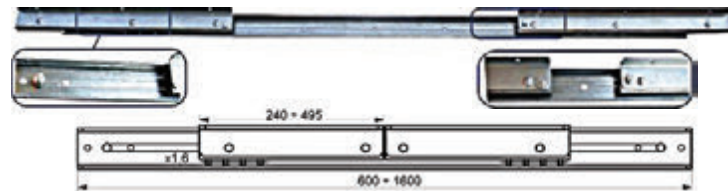

Prowadnica    długość stołu A    wkład B

L-60	90,5	42
L-65	95,5	47
L-70	100,5	52
L-75	105,5	57
L-80	125,5	62
L-85	130,5	67
L-90	135,5	72
L-95	140,5	77
L-100	162	82
L-110	172	92
L-120	182	102
L-130	202,5	104
L-142	206	107
L-150	214	115
L-160	224	122

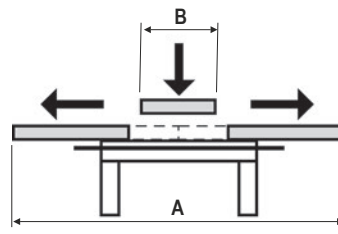

### Zaczepek do łózka cynk z korytkiem kpl

INDEX: ZKL

materiał stal ocynkowana

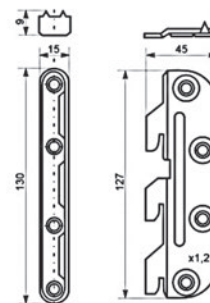
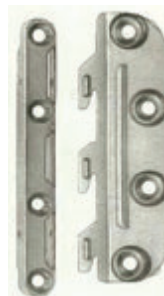

### Zaczepek do łózka środkowy

INDEX: ZLS

materiał stal ocynkowana

