

Złączka podwójna lewa/prawa R-6D(S)X
TR501-P/L-CHR

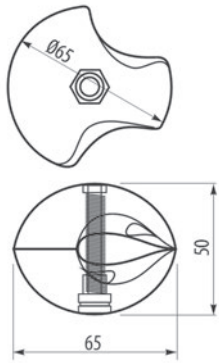

dostępne wersje INDEX
lewa R-6SX
prawa R-6DX

kolor chrom
materiał ZnAl

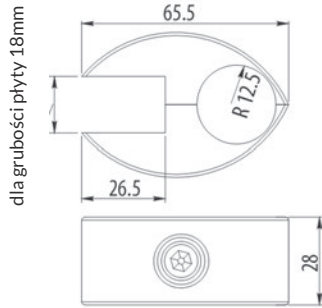

Złączka do szkła i płyty R-7
TR550-0-CHR

INDEX: A-SR-7

kolor chrom
materiał ZnAl

w opcji wkładka tworzywowa umożliwiająca
mocowanie półki szklanej - INDEX: R-47

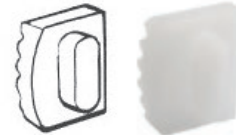

Złączka do szkła i płyty dwustronna R-7A
TR550-0-CHR

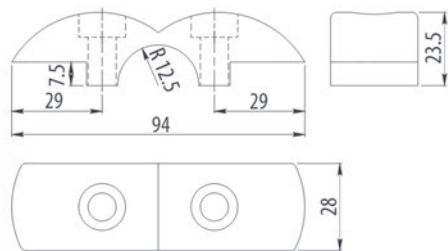

INDEX: R-7A

kolor chrom
materiał ZnAl

w opcji wkładka tworzywowa umożliwiająca
mocowanie półki szklanej - INDEX: R-47

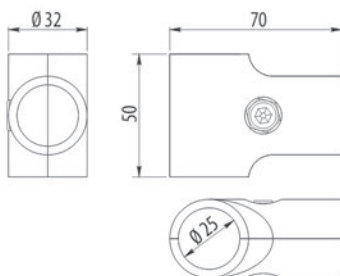
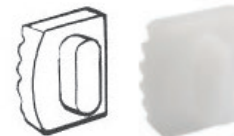

Złączka typ T R-8
TR551-0-CHR

INDEX: R-8

kolor chrom
materiał ZnAl

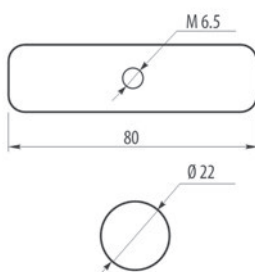

Przedłużka R-10
AC513-0-ALU

INDEX: R-10

kolor chrom
materiał ZnAl

Przedłużka z pierścieniem R-10 AC513-0-ALU

INDEX: A-SR-10A

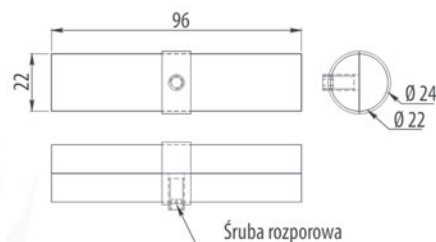
kolor ocynk
materiał ZnAl

Zaślepka metalowa mufa R-12M AC5045-0-CHR

INDEX: R-12M

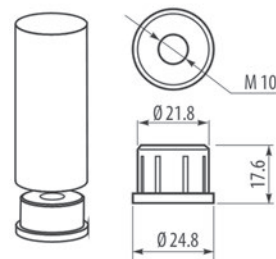
kolor chrom
materiał ZnAl

Zaślepka tworzywowa R-12P fi 25 z gwintem AC511-D-CZA

INDEX: R-12P

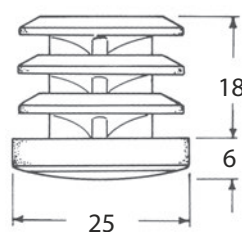
kolor czarny
materiał tworzywo

Stopka metalowa R-13 AC511-G-CHR

INDEX: R-13M

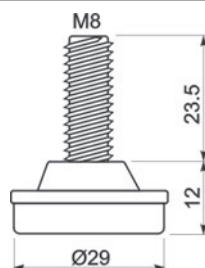
kolor chrom
materiał ZnAl + stal

Stopka plastikowa R-13

INDEX: R-13P

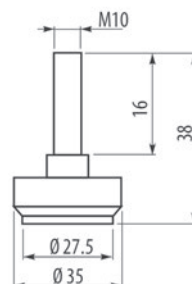
kolor czarny
materiał stal + tworzywo

Kółko podwójne fi 50 R-14B AC512A

INDEX: R-14B

średnica kółka $\varnothing 50$ mm

Kółko pojedyncze fi 80 R-14C AC512C

INDEX: R-14C

średnica kółka $\varnothing 80$ mm

R 15 Stopka plastikowa zewnętrzna R-15
AC514-0-CZA

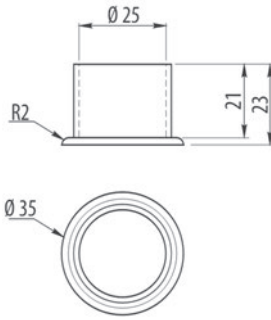

INDEX: R-15

kolor czarny
materiał tworzywo

Stopka plastikowa wewnętrzna R-16
AC508-B-CZA

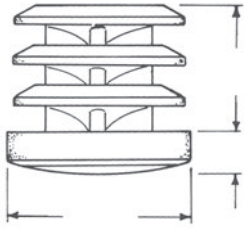

INDEX: AC508-B-CZA

kolor czarny
materiał tworzywo

Zaślepka płaska/półokrągła R-17(A)
AC507-0(D)

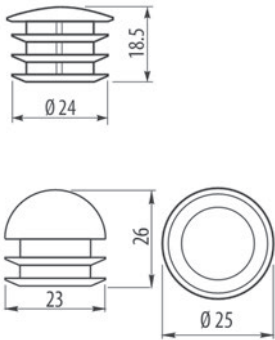

dostępne wersje INDEX

płaska R-17
półokrągła R-17A

kolor chrom
materiał tworzywo

Uchwyt do szkła plexi R-19A(C)
TR538-A-BZB/chrom

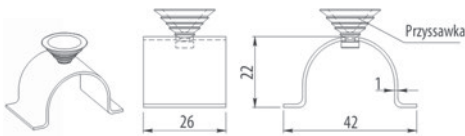

dostępne wersje INDEX

przezroczysta R-19A
chrom R-19C

materiał tworzywo

Uchwyt do szkła plexi R-20A
TR523-A

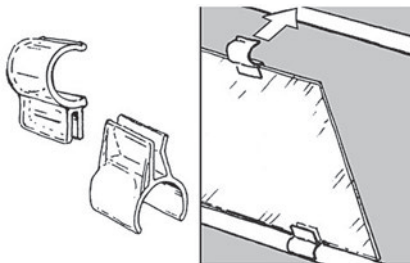

INDEX: R-20A

kolor transparentny
materiał tworzywo

Uchwyt poziomy do płyty R-21
TR520-0-CHR

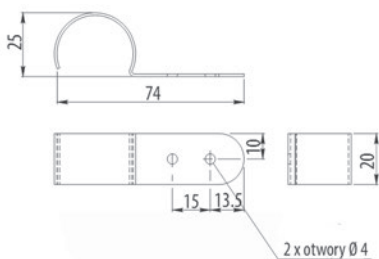

INDEX: ABM-R-21

kolor chrom
materiał stal

Uchwyt pionowy do płyty R-22
TR521-0-CHR

INDEX: ABM-R-22

kolor chrom
materiał stal

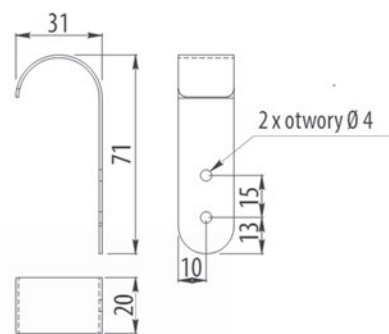

Kula ozdobna R-23
TR509-0-CHR

INDEX: R-23

kolor chrom
materiał tworzywo

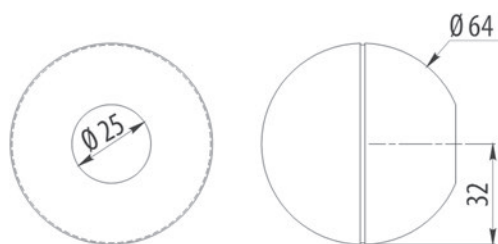

Profil z trzema łukami R-26/54
54 cm(94cm) TR537

dostępne wersje INDEX
L=54 A-M-R-26/54
L=94 R-26/94

kolor chrom
materiał ZnAl

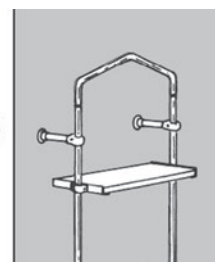

Profil 1/2 koła R-28(29)
fi 56(94) TR515-A-CHR

dostępne wersje INDEX
L=54 A-M-R-28/54
L=94 A-M-R-26/94

kolor chrom
materiał ZnAl

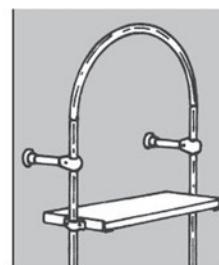

Kątownik 20x20 R-32
TR517-0-CHR

INDEX: R-32

kolor chrom
materiał ZnAl

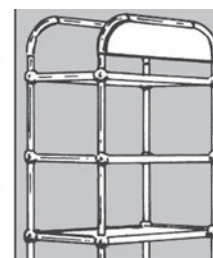
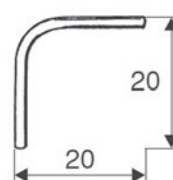

Narożnik ukośny R-32A(B)
TR576-0

dostępne wersje INDEX
20x20 R-32A
30x30 R-32B

kolor chrom
materiał ZnAl

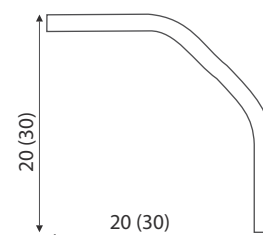

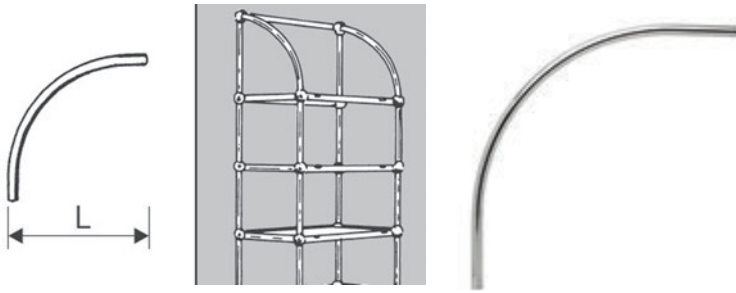

Profil 1/4 koła fi94 i 64 cm
TR516-B-CHR

INDEX: A-M-R-34

kolor chrom
materiał ZnAl

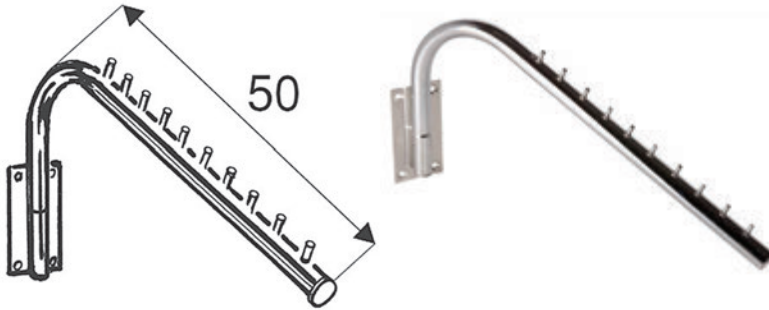

Wieszak W10 R-37/10
TR/ST537

dostępne wersje

INDEX

bez mocowania TR537-A
z mocowaniem ST537-C-CHR

A-M-R-37/10
A-M-R-37/M

kolor chrom
materiał ZnAl

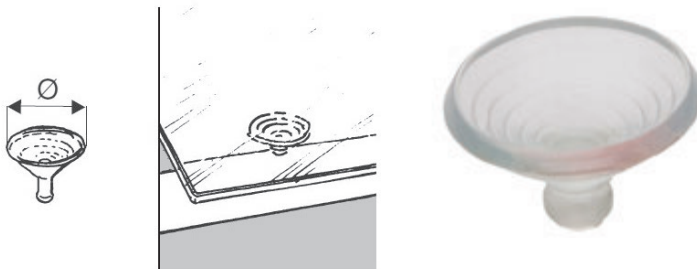

Przysawka do szkła R-40
AC565-A-BZB

INDEX: R-40

kolor transparentny
materiał tworzywo
Ø20 lub Ø25

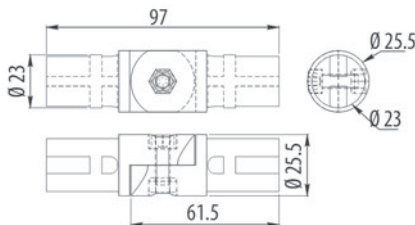

Złącze zawiasowe R-41
AC544-0-CHR

INDEX: R-41

kolor chrom
materiał ZnAl

Możliwość dostosowania kąta ramion złączek do założonego położenia (do 180°)

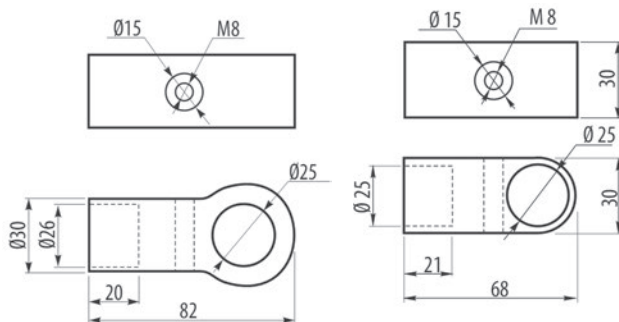

Złączka S końcowa R-42
TR560-0(A)-CHR

dostępne wersje

INDEX

złączka S
złączka S mała

A-SR-42
R-42M

kolor chrom
materiał ZnAl

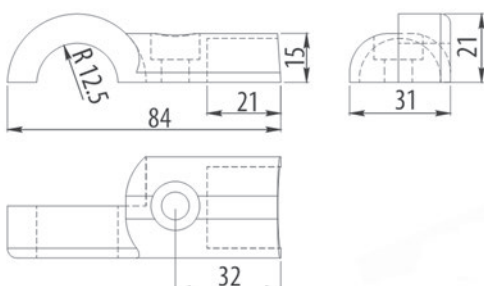

Złączka S kątowna R-43
TR561-0-CHR

INDEX: R-43

kolor chrom
materiał ZnAl

możliwość uzyskania różnych
położeń połączenia

Złączka S-T R-44
TR562-0

INDEX: R-44

kolor chrom
materiał ZnAl

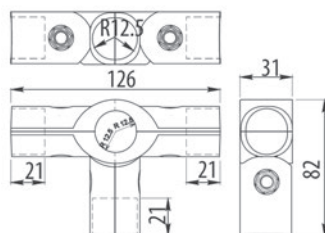

Złączka S krzyżowa R-45
TR5R563-0

INDEX: R-45

kolor chrom
materiał ZnAl

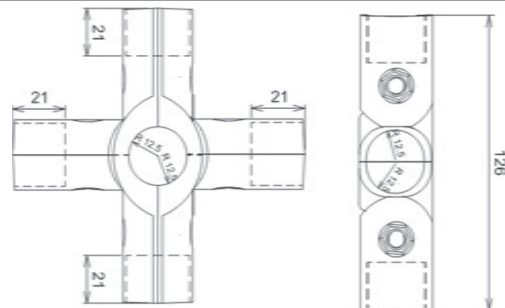

Złącze równoległe R-46
TR540-0

INDEX: R-46

kolor chrom
materiał ZnAl

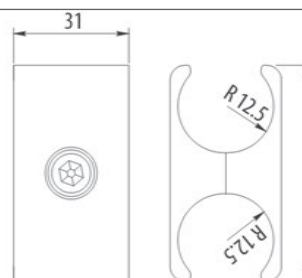

Wkładka R-46A do R-46
TR541-0

INDEX: R-46A

kolor biały
materiał tworzywo
dla grubości szkła 6 mm



Wkładka R-47 do R-7
TR552-A-BIA

INDEX: R-47

kolor chrom
materiał tworzywo

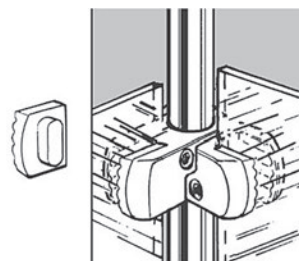

Złączka podwójna obrotowa R-48
TR557-0

INDEX: R-48

kolor chrom
materiał ZnAl

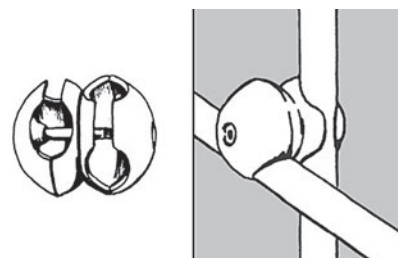

Uchwyt dystansowy R-50
AC570-0-0CHR

INDEX: R-50

kolor chrom
materiał ZnAl

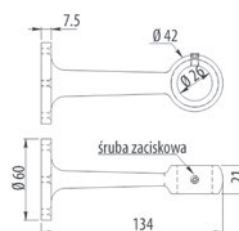

4 x pogłębienia stożkowe Ø 7.5 x 45°
Otwory Ø 4

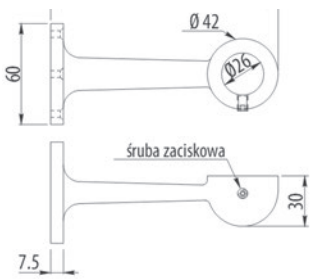

**Uchwyt dystansowy końcowy R-50A
AC571-0-CHR**

4 x pogłębienia stożkowe Ø 7.5 x 45°
Otwory Ø 4

INDEX: R-50A

kolor chrom
materiał ZnAl

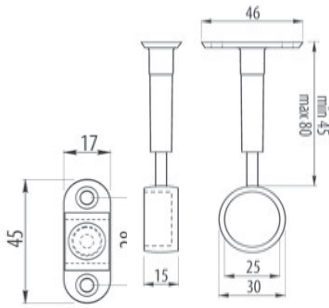

**Uchwyt dystansowy
końcowy/regulowany R-50A/R**

dostępne wersje	INDEX
przelotowy (AC936-0)	R-50/R
nieprzelotowy (AC936A-0)	R-50A/R

kolor chrom
materiał stal

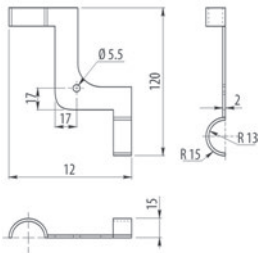

**Siodełko R-51
TR-564-0**

INDEX: R-51

kolor chrom
materiał stal

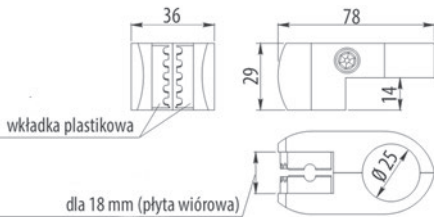

**Złączka zawiasowa do szkła, płyty R-52
TR553-0**

INDEX: R-52

kolor chrom
materiał ZnAl

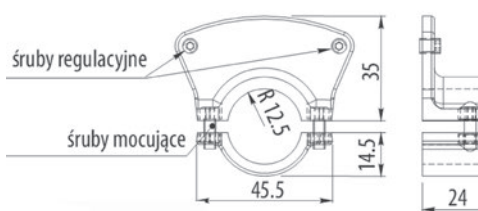

**Uchwyt do płyty jednostronny R-61
TR595-0-CHR**

INDEX: R-61

kolor chrom
materiał ZnAl

możliwość zamocowania półki
szklanej lub płyty wiórowej o różnych grubościach

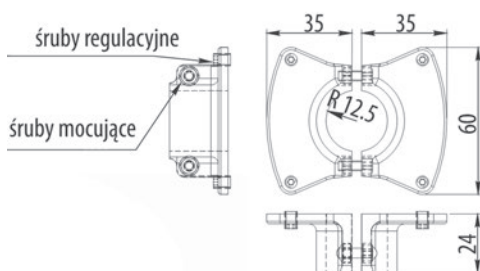

**Uchwyt do płyty dwustronny R-62
TR596-0**

INDEX: R-62

kolor chrom
materiał ZnAl

możliwość zamocowania półki
szklanej lub płyty wiórowej
o różnych grubościach

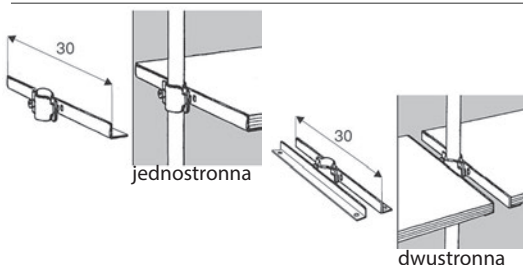

Konsola półki R-67/R-68

dostępne wersje	INDEX
jednostronna	R-67
dwustronna	R-68

materiał stal